

Field Control Layer Device

MFT28U

Individual LCD Touch Control Panel

【Description】

The MFT28U stand-alone LCD touch panel is a dedicated field operation man-machine interface for the DF.. series of networked fan coil controllers. It has a two-wire RS485 network communication capability and can be connected to a single fan controller to form a network. Through the MFT28U interface, the user can individually perform manual start-stop operation, schedule start-stop operation, temperature adjustment, wind speed switching, and timer shutdown control functions for the fan controller, as well as real-time monitoring and review of the fan's operating status. For example, on-site temperature value, system operation mode, wind speed operation status, fault alarm, etc., touch-sensitive LCD backlit screen, which can be operated to start, stop, change the temperature and humidity settings, etc.). MFT28U-Q is a version that incorporates air quality sensing functions, and users do not need to install additional air quality sensors. You can get the air quality value in the environment through MFT28U-Q. MFT28U can be mounted on the FCnet or SCnet network, allowing users to check the value or status on the controller at any time, and users can upload media screens through NTFeditor, and plan various corporate images or energy-saving promotional screens. Display during operation to enhance the added value of the product.



【Features】

- MODBUS communication can be connected to the SCnet layer communication of AIRTEK DFC series products, which is convenient for on-site personnel to operate.
- The 2.8" TFT LCD touch screen is used to display various information content, with simplified/traditional/English operation menus, and menu settings can be switched directly.
- The control screen is divided into the main control screen and the advanced setting screen. Generally, the user can control the comfortable conditions by operating the main control screen through the panel buttons.
- The main control screen has 4 backgrounds for users to choose from, each with 3 different pages for air conditioning, heating, and air supply, for a total of 12 screens.
- With advanced setting function selection screen, when the main control screen is displayed, tap anywhere on the screen to enter the advanced screen, with mode selection, sleep comfort, energy saving, scheduled power-on, scheduled power-off, timer power-off, system settings, products Information, password and other functions.
- You can update the firmware and upload image data through the Mini USB interface.
- With the function of uploading media screens, plan all kinds of corporate images or energy-saving promotion screens, set up to 18 pictures, displayed when there is no operation, set up to 18 pictures, to enhance the added value of the product. You can choose to play or not to play.
- With language, lock, temperature unit, background setting, buzzer, media playback, brightness, clock mode, clock setting adjustment and other parameter setting functions.
- Clock mode setting, when monitoring connection, you can choose to read the clock, with the network time automatic synchronization function, and accept the network time correction of the central monitoring, so that the controller time in all systems is the same. When there is no monitoring connection, you can choose the clock to write out, and the panel will display the time, and the connected controller will be synchronized.
- MFT28U-Q contains temperature, humidity, and carbon dioxide sensing functions, which can sense indoor air quality and return its values to the central monitoring network.

【Specification】

Model	A/C Control	Temperature	Humidity	CO ₂	IAQ Display
MFT28U	○	X	X	X	X
MFT28U-Q	○	○	○	○	○





Power Supply : 5VDC, 3VA (Can use the 5VDC power supply V+, V- on the SCnet port of the AIRTEK DFC.. controller).

Display : 2.8" TFT LCD touch screen, full-color 65,536 colors, resolution 320*240 modules.

Microprocessor : 32-bit high-speed computing microprocessor (MCU) with 64K SRAM and 384K Flash memory space, additional 8M font library and user data memory.

SCnet interface : RS-485 communication interface, the maximum transmission distance is 1,200 meters.

USB interface : Mini USB transmission interface for firmware update and graphic control data download.

Function keys : 4 function keys.  for fan start and stop, 、 for temperature adjustment,  fan speed setting.

Buzzer : For operation and alarm prompts.

Environment : 0~50°C, 5~95%RH non-condensing.

Temperature : Temperature/humidity chip, range 0~50°C, accuracy is ±0.4°C (measured at 25°C).

Humidity : Temperature/humidity chip, range is 0~100%RH (non-condensing), accuracy ±3%RH (at 10~90%RH/25°C)

CO2 : NDIR non-dispersive infrared sensor, range, 0~10,000ppm, accuracy ±40ppm ±3%

Certificate : CE, RoHS

Accessories : HMI-LINKER

【Application】

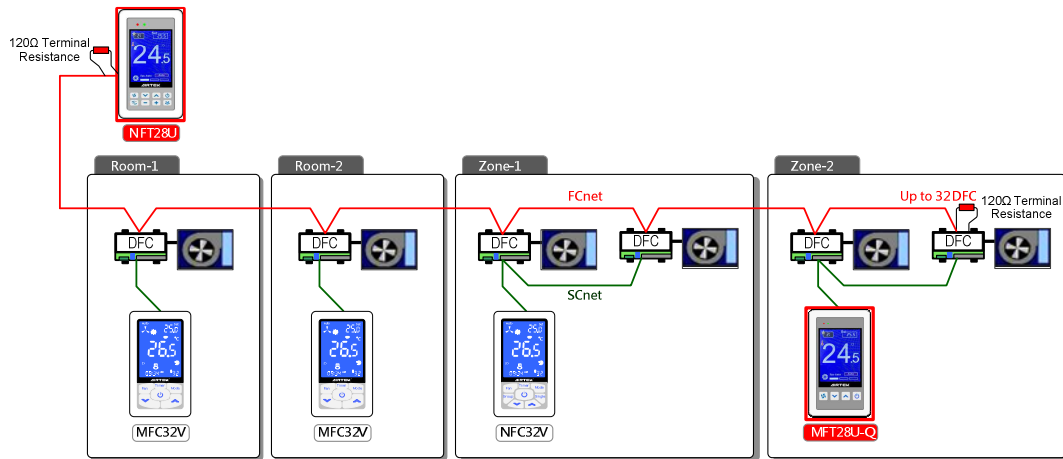

【Installation】

- Please read the catalog carefully before installation. Failure to follow the instructions in the catalog may cause danger or cause unpredictable results such as product damage.
- Do not connect the panel to the power supply during installation, because of the danger of electric shock or equipment damage, which may cause personal injury or damage the electrical circuit.
- Please install the control panel on the wall about 1.2 meters above the ground and in a location with good ventilation and circulation. Do not install it in a location that is directly exposed to heat, damp, dusty or vibrating, so as not to affect the control effect or product life.
- The transmission distance between the main communication network FCnet and the sub-communication network SCnet is less than 300 meters. It is recommended to use AWG22~24#2C paired copper mesh to isolate and shield the cable. For more than 300 meters, it is recommended to use AWG18~20#2C paired copper mesh for isolation. The cable must be shielded and must have an impedance of ①100~130Ω ②The capacitance between the conductor and the conductor must be less than 100 pF per meter ③The cable wire between the copper screen of the conductor is less than 200 pF per meter.
- The RS485 communication network must adopt a daisy chain connection mode of one input and one output, and it cannot be divergent or star-shaped, and keep the positive and negative polarity of the potential consistent.
- The front and back ends of the RS485 communication network should be equipped with 120Ω terminal resistors to effectively improve the stability of communication quality. The total length of the network should not exceed 1,200 meters.
- When the group control panel is within 20 meters from the DF.. controller, you can use AWG22~24#4C twisted copper mesh isolation shielded cable to connect (two of the cores are used for connecting to the power supply), and the DF.. controller can be used nearby. 5VDC power supply (terminals V+&V-) on the power supply; if the distance exceeds 20 meters, a 5VDC power supply must be configured independently. Remember! Do not share the power supply with other equipment, so as to avoid the short circuit burnout caused by the difference in circuit design.
- FCnet and SCnet communication networks should be covered with EMT metal conduits, and should not be co-managed with power lines or power lines to avoid noise interference.
- To download the graphic control screen, set the parameters or update the firmware version of the panel, you need to use the computer to run the NFTeditor software to operate. **Notice! Please unplug the external 5VDC power supply before connecting to the computer**, and then connect it to the computer with a Mini USB transmission cable, and use the computer's USB port to directly supply 5VDC, so that the computer and panel information can be transmitted smoothly.

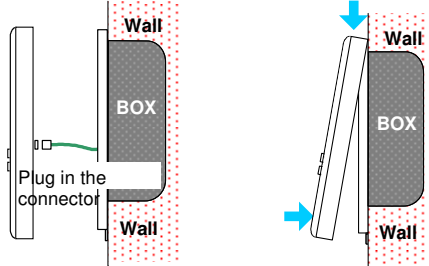
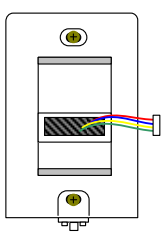

Fig.1 Installation

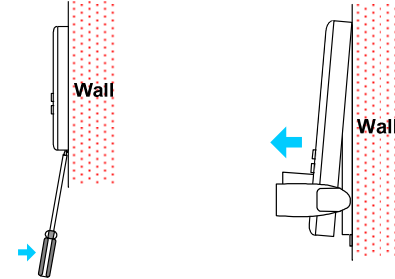
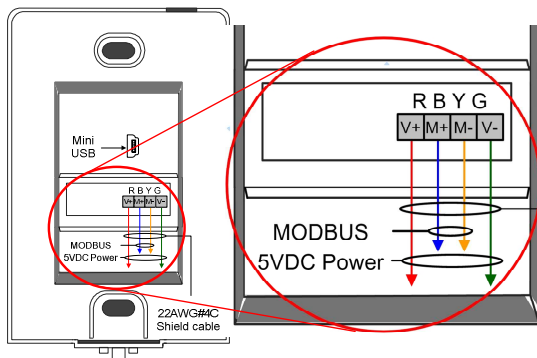

Fig.2 Dismount

【Wiring】



【Dimensions】 Unit : mm

